



# The Impact of Internet of Things (IoT) on Cable Certification

Simon Harrison

General Manager

Softing Singapore Pte Ltd

**softing**

November 2017

**Bicsi**



## Agenda

- Review of traditional structured cabling configurations
- Special cabling requirements for IoT devices
- Cabling architectures used with IoT devices
- The new link concept: End-to-End links (E2E)
- Testing requirements for E2E cabling
- New standards for testing
- Practical guidelines
- Outlook towards future applications
- Summary



## Review of traditional structured cabling configurations

Test	Implications for Testing
<b>Permanent Link</b> <ul style="list-style-type: none"><li>• Permanently fixed installed cabling</li><li>• May contain also a consolidation point</li></ul>	<ul style="list-style-type: none"><li>• Tester must set reference plane so that first &amp; last connector of link is included in measurement</li><li>• Test cords have special test plugs</li></ul>

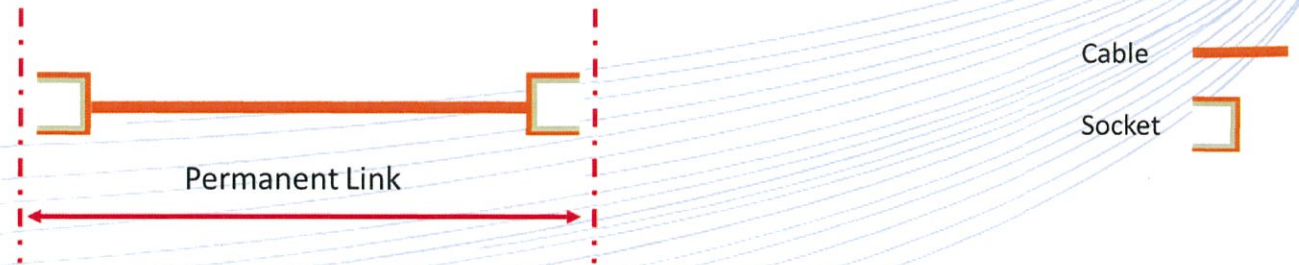



## Review of traditional structured cabling configurations

Test	Implications for Testing
<p><b>Channel</b></p> <ul style="list-style-type: none"><li>•Permanent Link</li><li>•+ all attached patch cords and cross connects</li></ul>	<ul style="list-style-type: none"><li>• Tester must include any patch cords</li><li>• First and last connectors of cords are <b>EXCLUDED</b> from the measurement</li></ul>

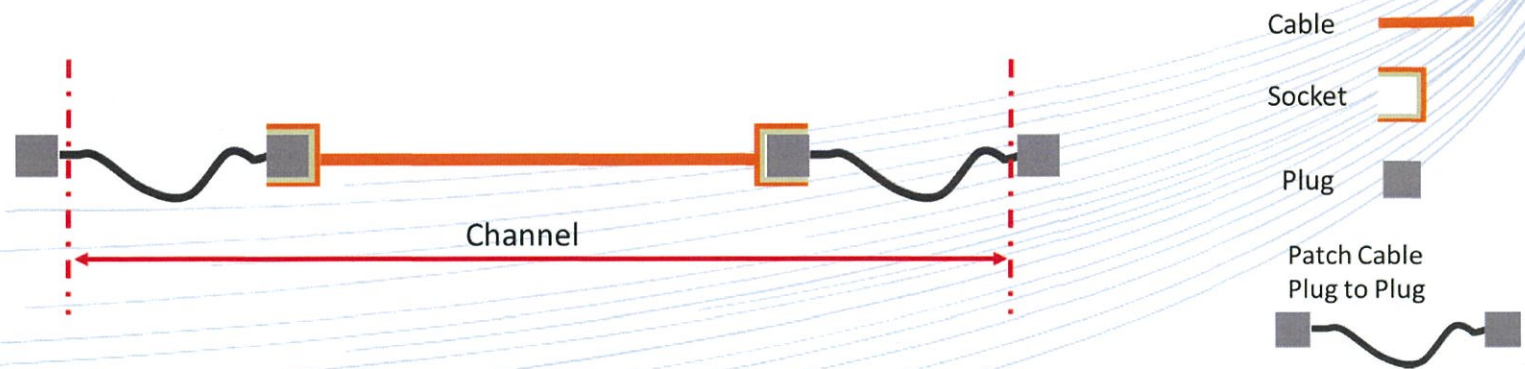



# Review of traditional structured cabling configurations

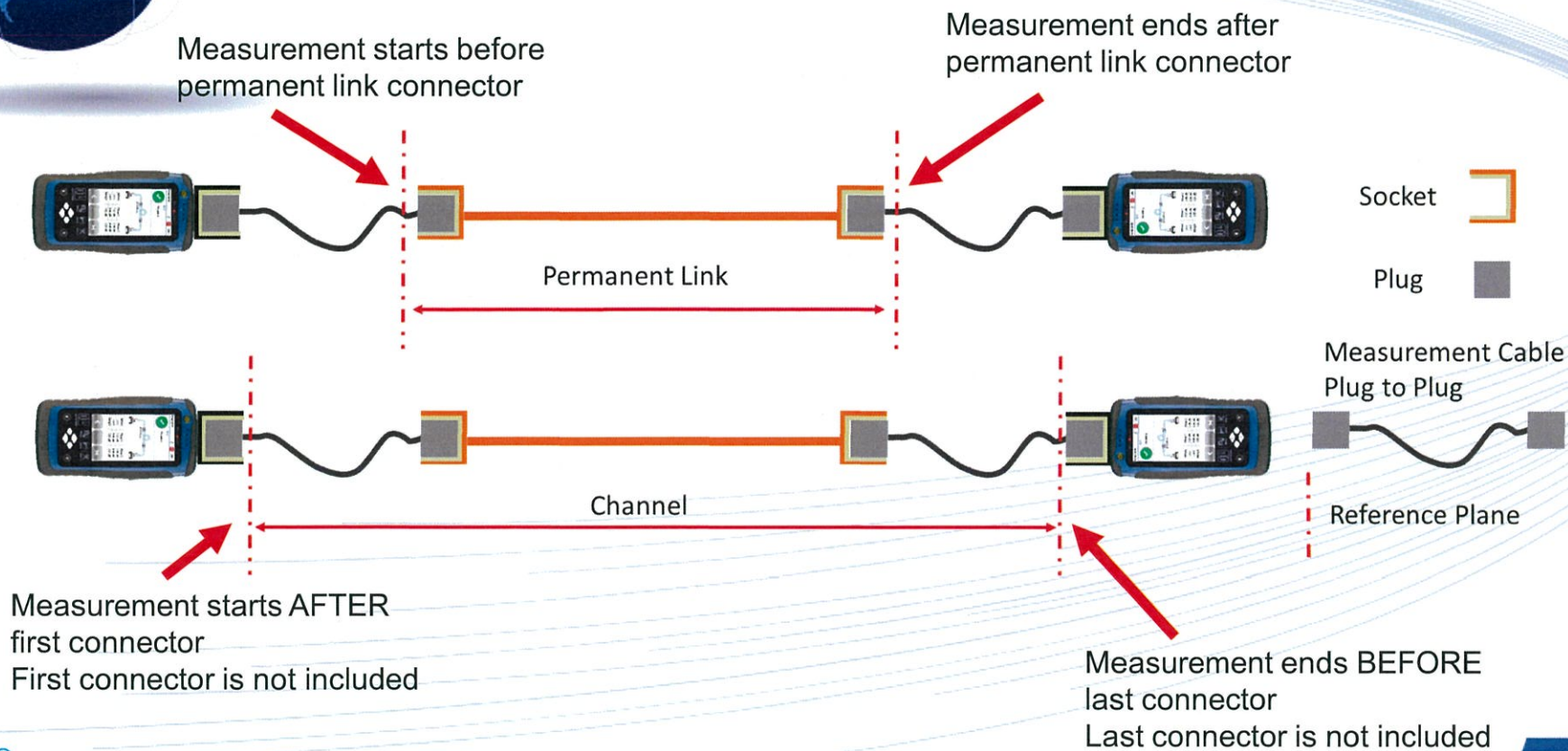



## Special cabling requirements for IoT devices

Conventional Channel or Permanent Link is often impractical

- Devices often need to be connected without an extra patch cord
- There is no structured cabling outlet at the required location

Examples:

- Access points or cameras on walls
- Sensors
- Building automation devices

Length

- In future, the conventional limit of 100m will not be enough...

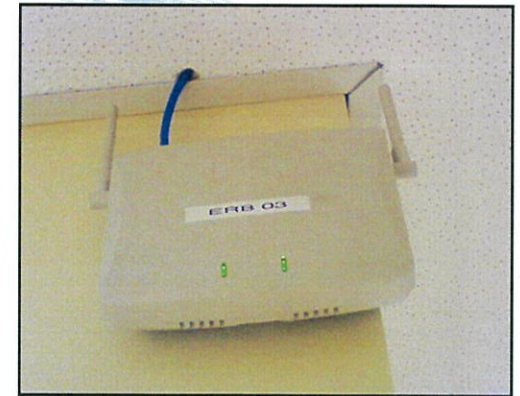



## Special cabling requirements for IoT devices

### Connectors

- “Office” RJ45 often is not enough
- Now there is a variety of different connectors:
  - Ruggedized RJ45 housings - dustproof, waterproof, oil proof, mechanical protection
  - M12, D coded and X-coded
  - M8
  - IX
  - Terminal screws
  - **Future: various 1 pair connectors**



⇒ **This is a challenge for the field tester – we need to provide connectivity for all kinds of different systems!**







# Cabling architectures used with IoT devices

Star Topology vs Daisy-Chain or Point-to-Multipoint

IoT Cabling – Mix of „Star“ and „Daisy Chain“ Configurations

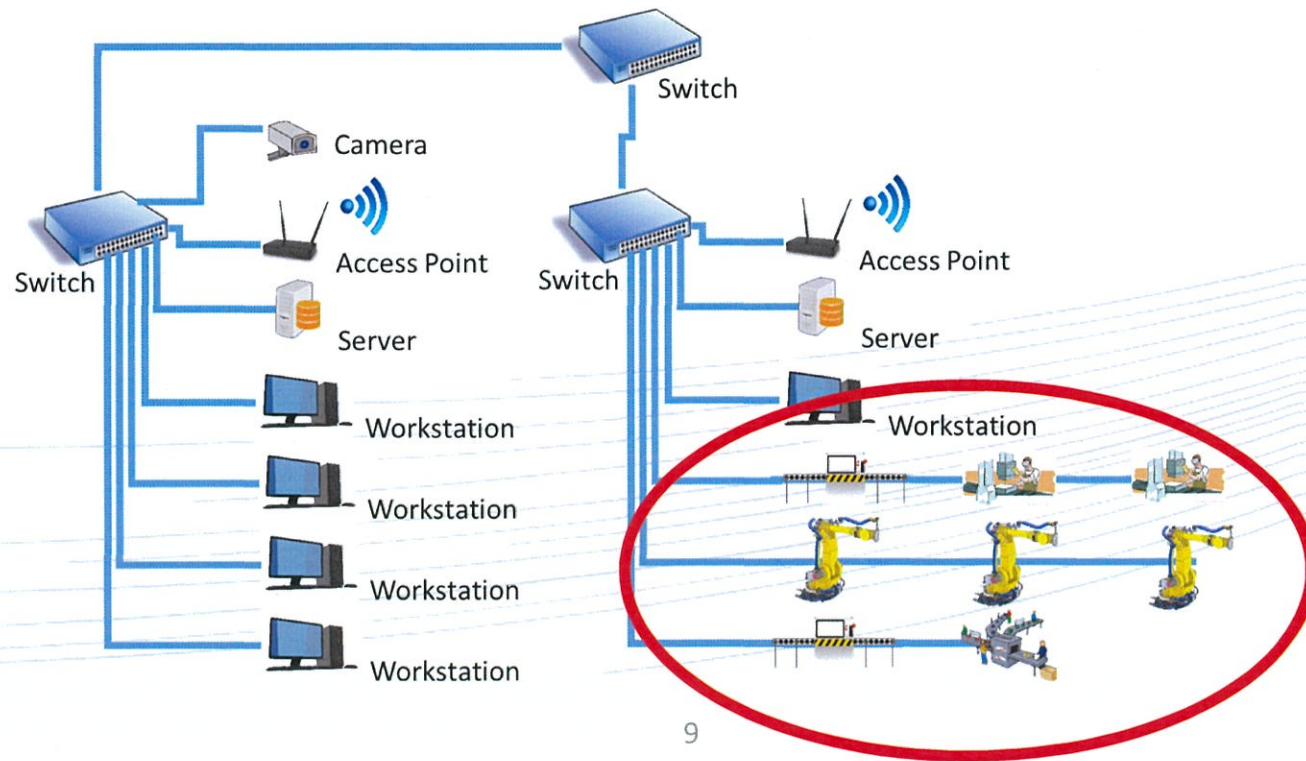



## The new link concept: End-to-End Links (E2E)

- New: E2E link configuration - E2E = End-to-End
- Up to 100m on solid wires, ~ 80m on stranded (depends on brand)
- “Looks like” a permanent link – but note that an E2E has plugs at the ends, not sockets
- Purpose: Direct connection between equipment without using patch cables

Plugs at the ends need to be included in any test **because they can be terminated in the field**

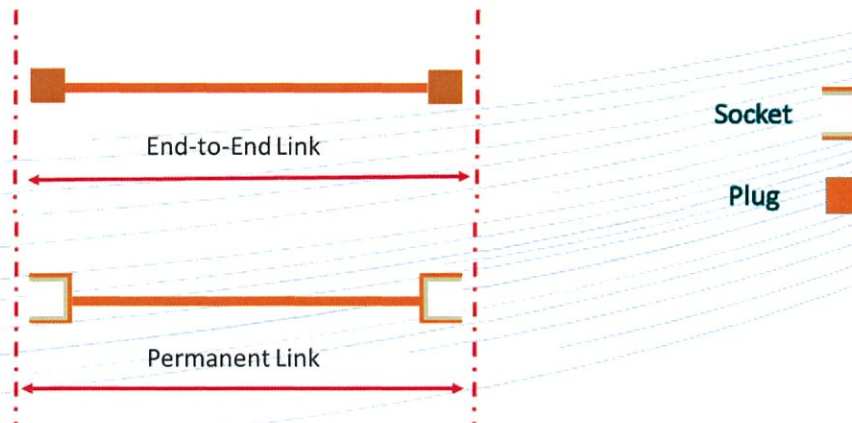



## Testing requirements for E2E cabling

Implications for field testers:

- Conventional Channel test setup CANNOT be used because Channel tests do NOT include the first and last connector

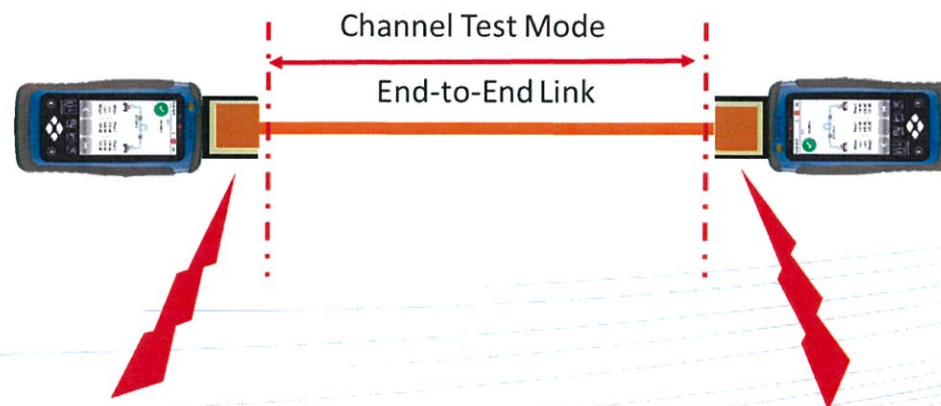

**Failures due to field termination other than simple wire-map errors can not be found using Channel mode!**



## Testing requirements for E2E cabling

Two possible approaches to include first & last connector:

A: Use dedicated adapters with an E2E reference plane

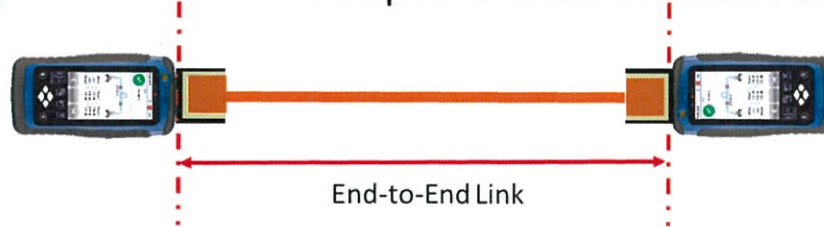

B: Use dedicated adapters and test cords with sockets

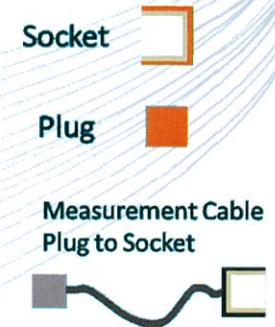
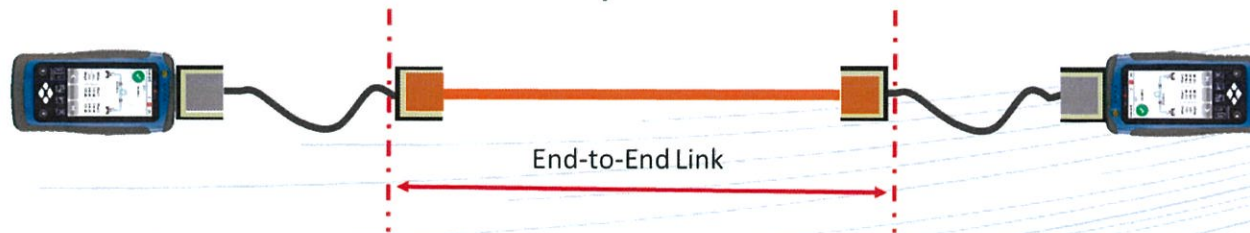

➤ Advantages of B

- **More flexible – easier to reach tight locations on equipment**
- **Easier to implement new connectors**



## New standards for E2E links

- IEC14763-4: Measurement methods to test E2E links
- ISO11801-9902: Testing of E2E links
- ANSI/TIA 1005: Infrastructure for Industrial Premises

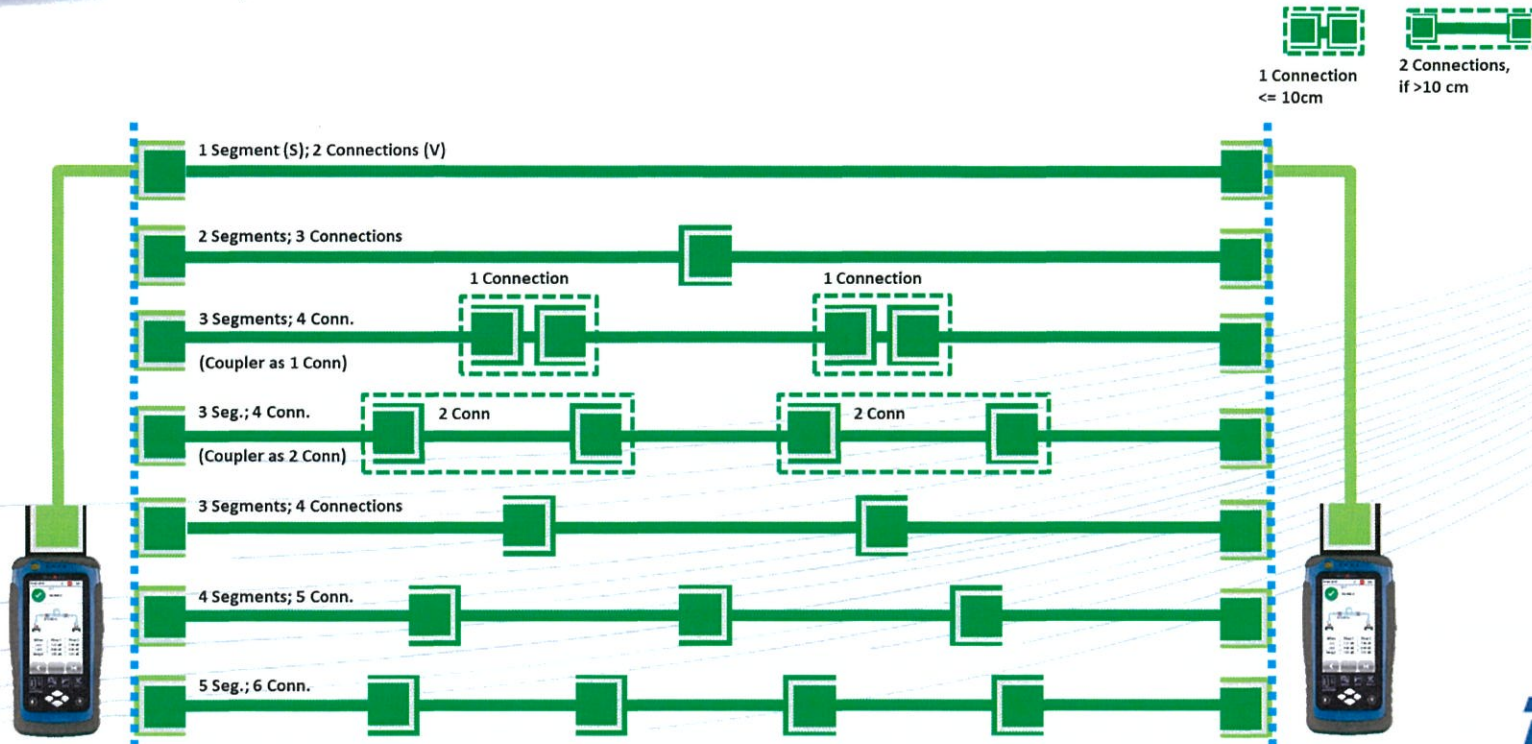

## New standards for E2E links

- To best possible reflect the real-world requirements for IoT devices, those standards contain various E2E link configurations: from 1 to 5 segments.
- Note that 2 connectors close to each other may be seen as 1 or 2 connections.
  - “1 connection” if the distance between 2 connectors is less than 10cm (= a bulkhead).
  - “2 connections” if the distance is more than 10cm.
- A segment may also contain a “socket to plug” assembly.
- At current, standards only define E2E up to CAT6 / Class E.

- **Another important difference to channel testing:**

**All the different configurations have different testing limits**

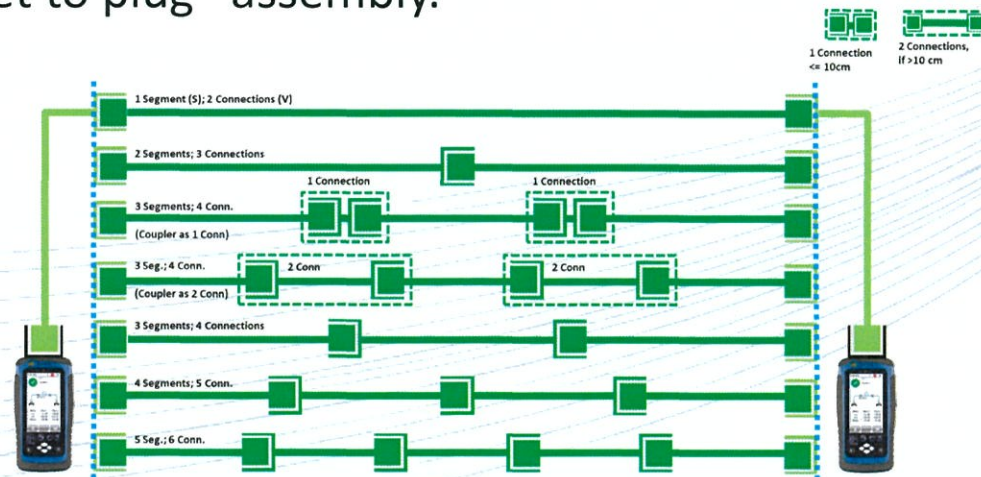



## New standards for E2E links

Important differences to patch cords

- An E2E link is NOT a patch cord
  - A patch cord is one part, an E2E link can consist of up to 5 segments
  - Different length, different cable types (solid, stranded, different diameters)
  - Different testing requirements
- An E2E Link always has to be tested as a complete link
- Adding more segments requires re-testing of the complete link

Sum of 3 individual segments



≠

3 segments joint with bulkheads





## Practical guidelines

- Make sure your tester supports E2E links – check the list of available limits
- At present, standards only define E2E measurements up to CAT6 / Class E
  - so maximum supported speed for Ethernet is 1000MBit/s
- Hybrid cords can help to access tight locations
  - make sure the device is able to handle measurement using hybrid cords with the correct reference plane

End to End
ISO - Five Connection Class D E2E Link
ISO - Five Connection Class E E2E Link
ISO - Four Connection Class D E2E Link
ISO - Four Connection Class E E2E Link
ISO - Three Connection Class D E2E Link
ISO - Three Connection Class E E2E Link
ISO - Two Connection Class D E2E Link
ISO - Two Connection Class E E2E Link







## Practical guidelines

So how should we figure out an unknown link configuration?

- Use a device with time-domain features for NEXT or Return Loss, usually referred to as “TD-NEXT” or “NEXT Locator” and “TD-RL” or “RL Locator”.
- Run an Autotest with the Locator feature enabled.
- Look at the NEXT or RL Locator results. The peaks will tell you how many connections are present in that link
- If the E2E link consists of more than one segment, you will need to visually check at the positions shown on the Locator to see if each peak is to be treated as one connection or two.
  - 10cm is less than the typical resolution of time domain features on certifiers.

Example:  
2 Segment E2E link

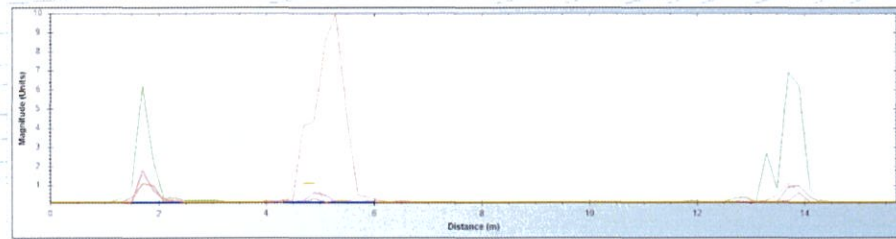



## Outlook – other examples of potential E2E applications

- **Data Centre**  
Direct connection between devices  
For example servers in the same row  
(But note: E2E is not yet standardized for CAT6A / Class E<sub>A</sub>)
- **Professional Entertainment**  
Cabling “on the fly” for stage equipment, sound and lighting
- **Home Networking/Entertainment**  
Wi-Fi is of course very important, but some devices still need copper connections – for example:
  - Access points
  - IoT gateways for proprietary wireless systems
  - IPTV boxes



## Outlook – what comes next?

### E2E and 10GBit/s

- Next revision of ISO standards for E2E will contain limits up to CAT6A / Class E<sub>A</sub>

### 1 Pair – various new configurations – new field of applications

- 15m and 40m
  - Mainly interesting for automotive applications  
15m for cars, 40m for buses and trucks, **minimum 1GBit/s**
  - Car sensors, cameras, actuators, controls, entertainment
- 1000m, 10MBit/s
  - Very interesting for industrial automation, IoT devices
  - Drive any sensors, building automation devices, cameras
- PoDL: **Power over Data Lines**
  - 1 Pair cabling to provide power to IoT devices



## Outlook – what comes next?

### Newest ideas for 1 pair

- Adopt 1 pair cabling for office applications
  - 100m, 1000MBit/s
  - New “consolidation point”-like structure  
4 pair to a “consolidation point” and  
then 4 x 1 pair to 4 devices
- Reasons
  - Many office devices do not need more than 1000MBit/s
  - Laptops are becoming so thin that they cannot accommodate an RJ45
  - Provide a copper Ethernet link to tablets, monitors, terminals using the smallest possible cable and connector

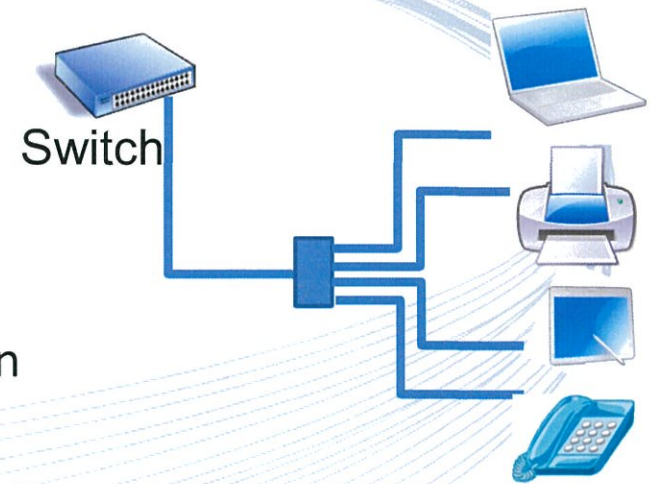



## Summary

- IoT opens up a wide range of new cabling and testing applications
- Increasing speeds and the performance requirements of these new applications make testing absolutely necessary
- Testing of IoT cabling requires special testing approaches and MUCH more flexibility in terms of what needs to be tested
  - Various different connector types
  - Various different configurations
    - Not just Permanent Link and Channel
- First round of IEEE , ISO/IEC and TIA standards are released, but this is just the beginning:
  - Further standards will follow to cover new applications



**Questions?**

**Thank you for your attention**

**softing**

**Bicsi**